

The Recyclesaurus Activity Book

"Away With Waste"

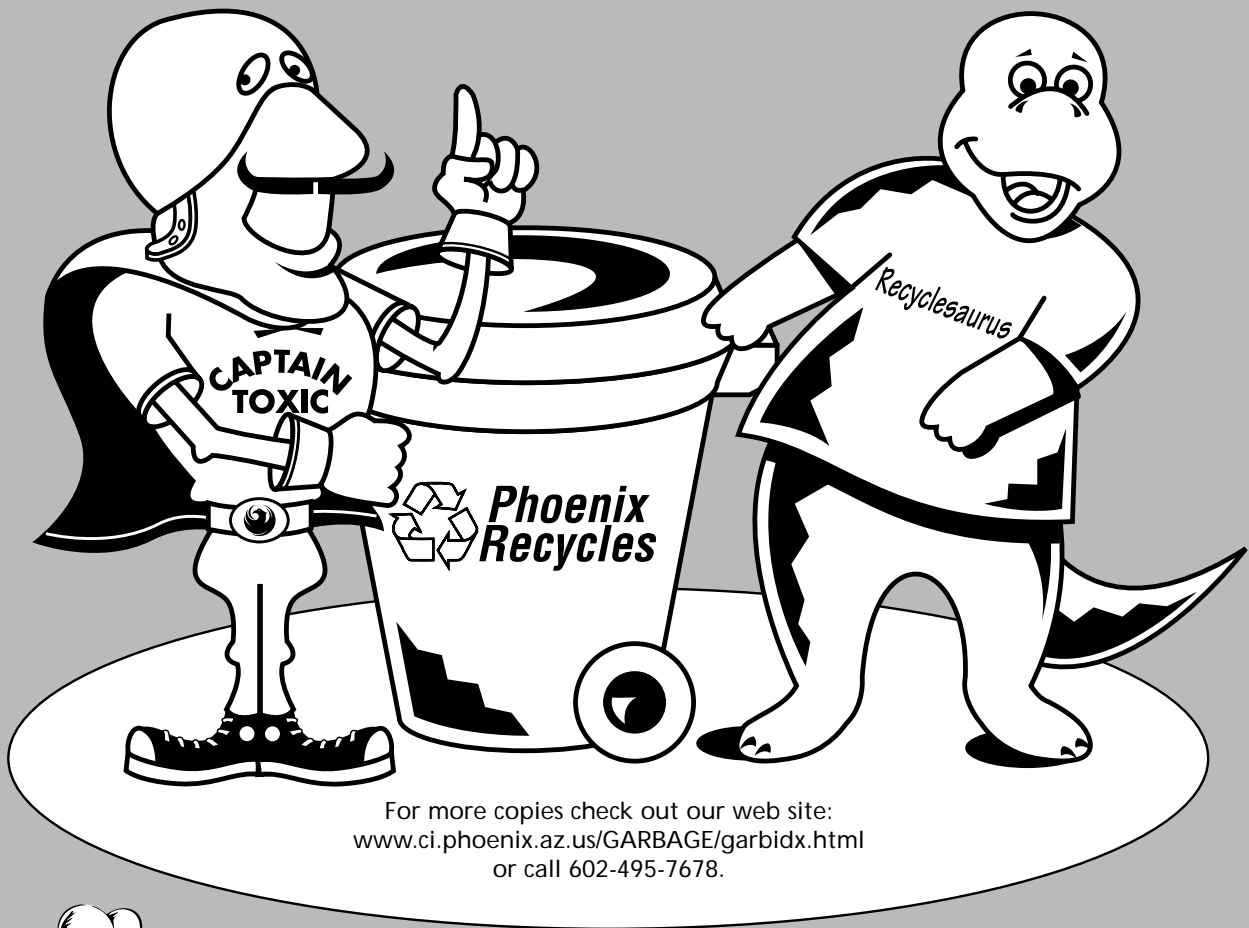

For more copies check out our web site:
www.ci.phoenix.az.us/GARBAGE/garbidx.html
or call 602-495-7678.



Wild Bill Pickup

Brought to you by:



City of Phoenix
PUBLIC WORKS DEPARTMENT



Printed on recycled paper

How can you keep Victor T. Vector from playing in the garbage?

Use the code below to unscramble these helpful messages.

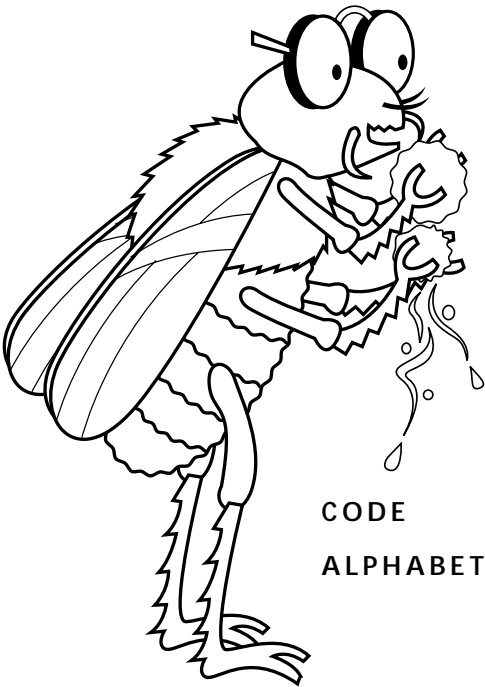

VXP XWB MJQ LKYF PXFVXPO XWB PFXE E

CQQO MIQ PXFVXPO AXW UJB AUKEQB

CQQO X UJB KW JM

CODE X V A B Q Z P I J D C U G W K O H F E M Y N R S L T

ALPHABET A B C D E F G H I J K L M N O P Q R S T U V W X Y Z

Litter Prevention

Color the picture that shows the right way to prevent litter.

1

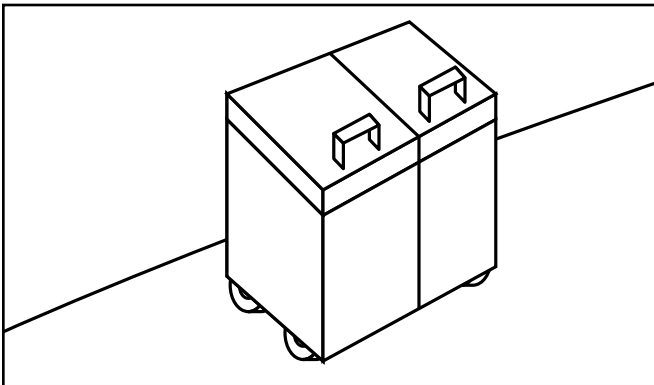

2

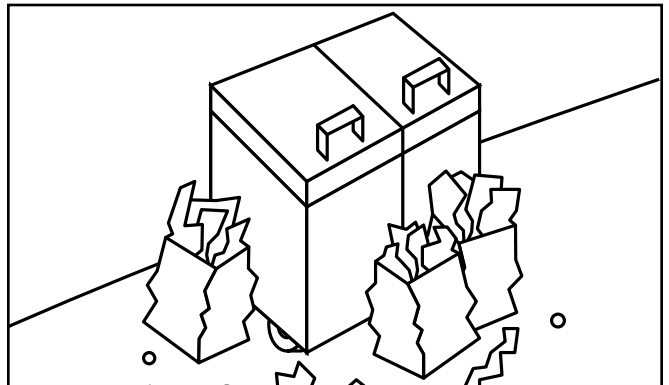

1

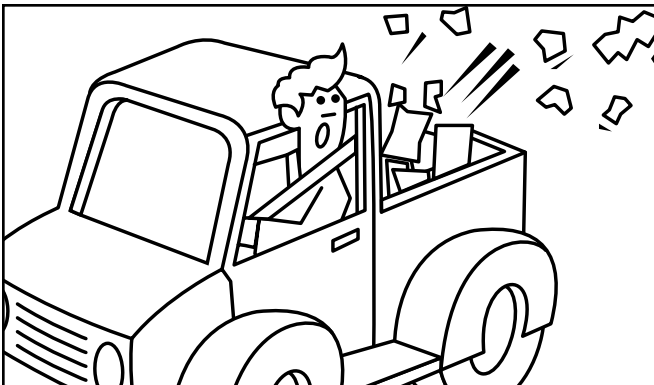

2



Phoenix Recycles

Circle the items below that belong in the blue recycling barrel.

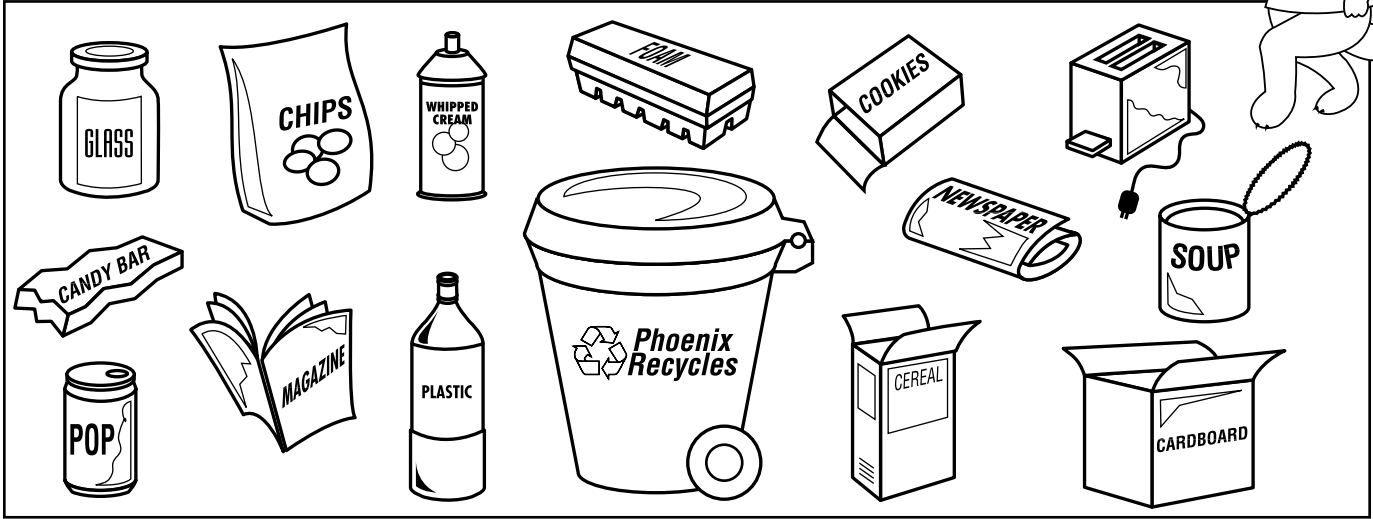
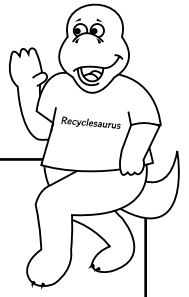

Answer: Everything but potato chip bag and candy wrapper.

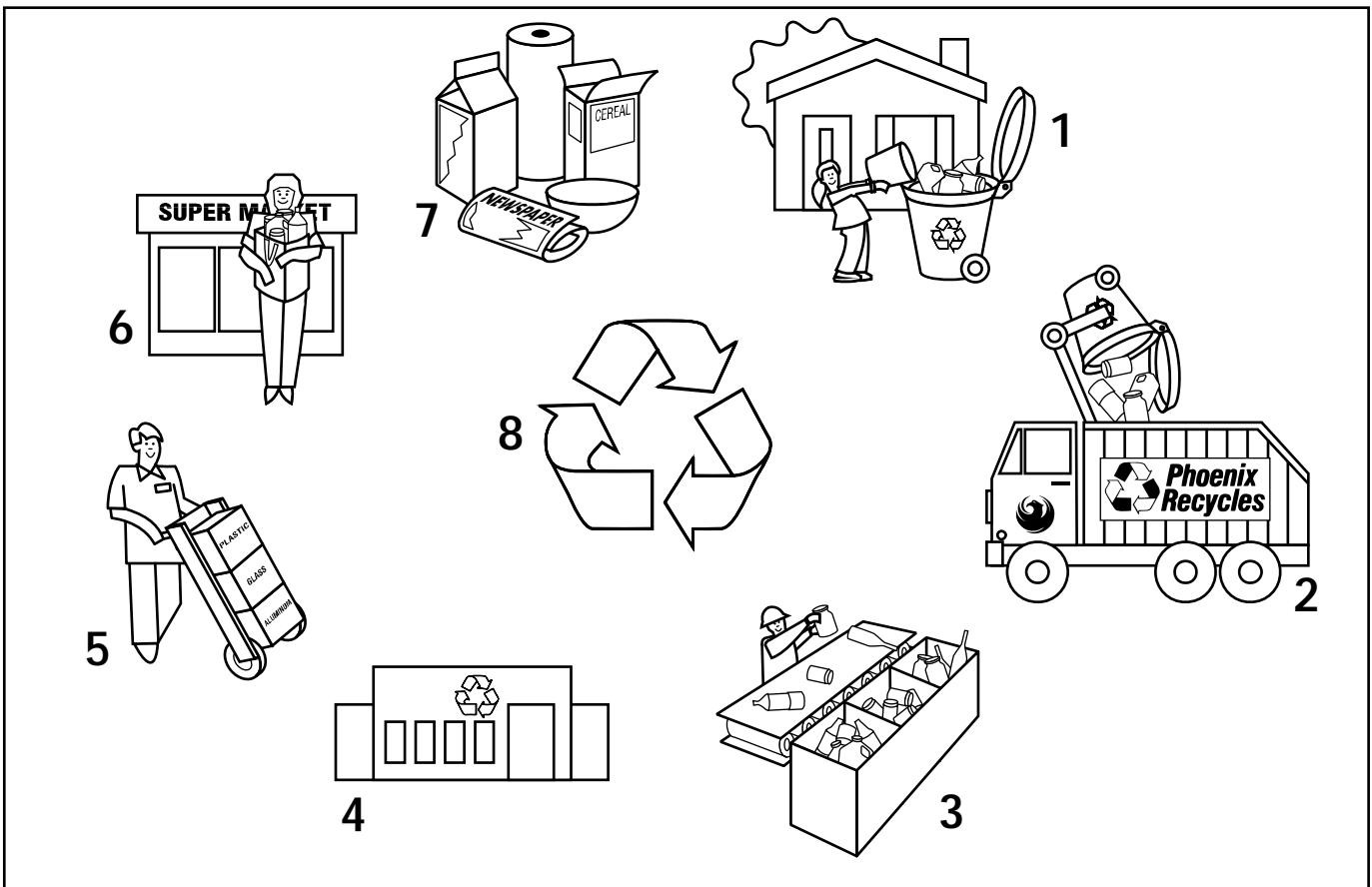

Answers starting in first column: 1,3,6,2,4,8,7,5.

Match the number above to the correct process of the recycling loop

- | | |
|---|-------------------------------------|
| ___ Place materials in blue bin at home | ___ Recycling factory |
| ___ Materials sorted | ___ Recycling Symbol/Completed Loop |
| ___ Buy recycled materials at the store | ___ Using recycled goods at home |
| ___ City of Phoenix collects materials | ___ Recycled goods to the market |

Solid Waste/Garbage Collection and Disposal

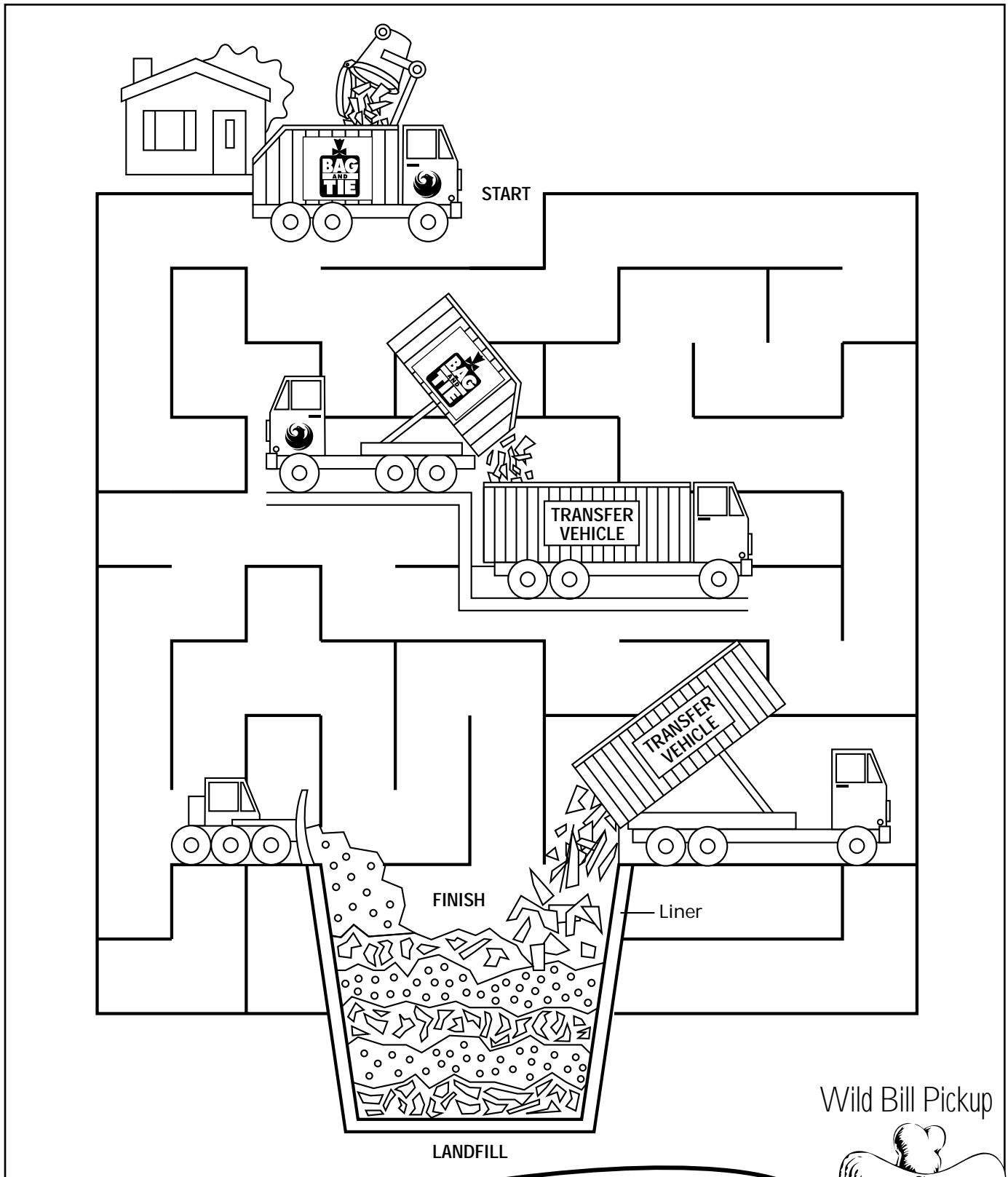

Wild Bill Pickup

Help the garbage truck and the transfer vehicle through the maze to get the garbage from your home to the landfill.

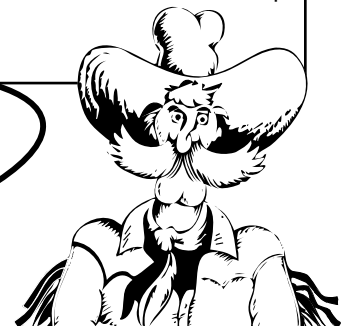

Can you think of another way for Recyclesaurus to reduce garbage?



Buy bulk items — they use less packaging.



Use cloth shopping bags — over and over again.

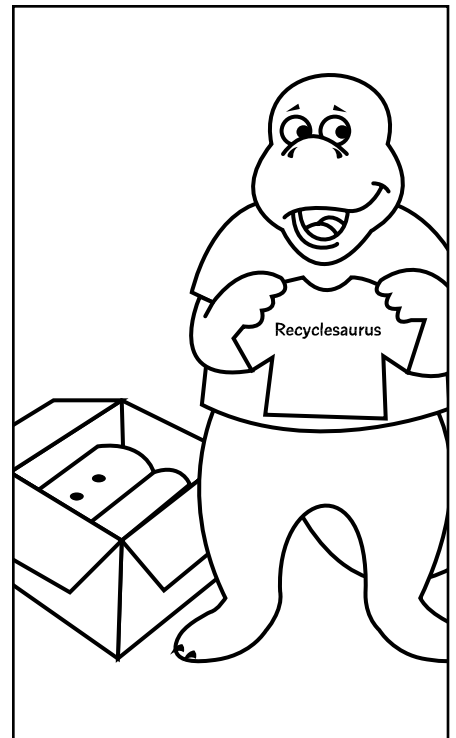

Donate used clothing — don't just throw away.

Can you think of another way for Recyclesaurus to re-use a paper tube?

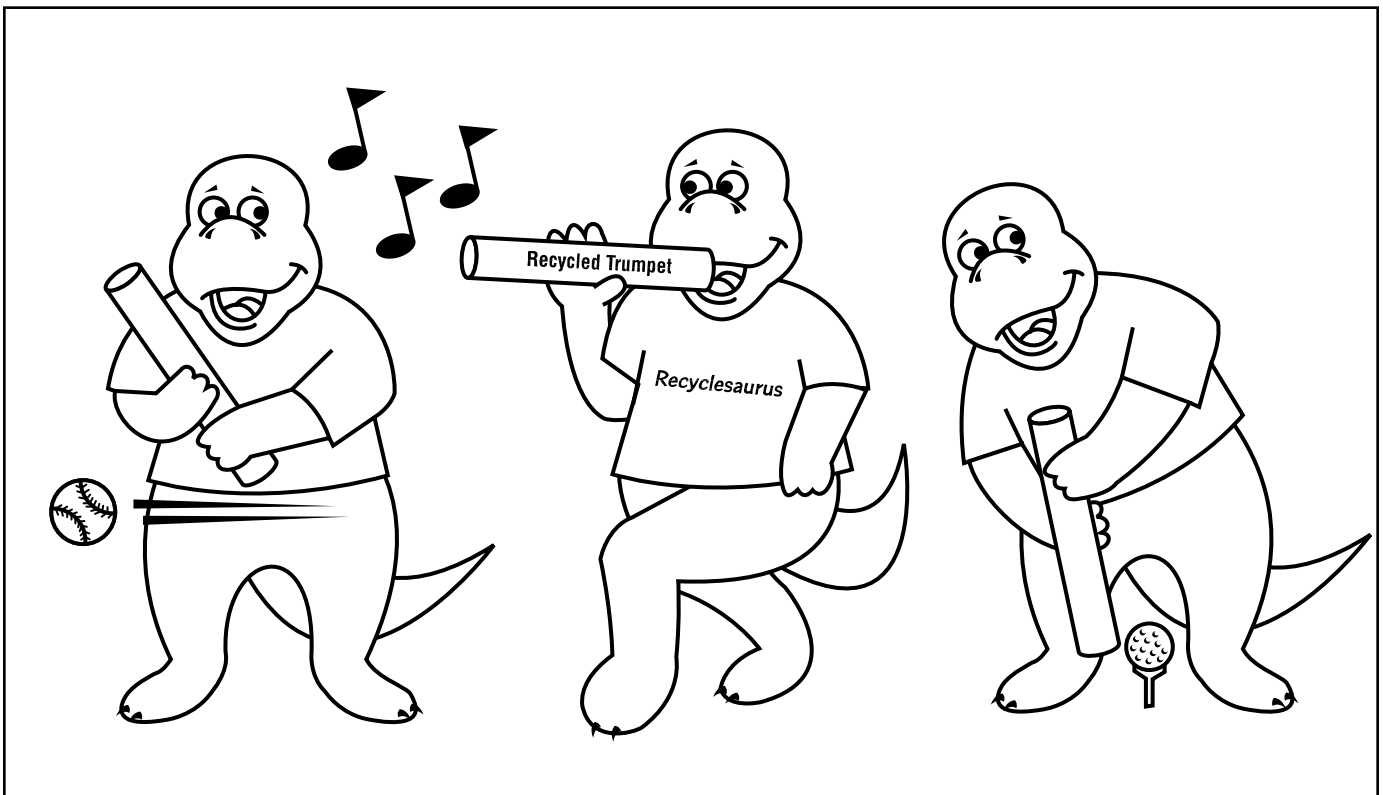

If you have a neat idea on how to reuse or recycle solid waste you can write Recyclesaurus at: Recyclesaurus, 101 S. Central Ave., Phoenix, AZ 85004 or e-mail to: resaurus@ci.phoenix.az.us



Do belong: Cactus, coyote, roadrunner, rabbit, bushes, snake, sun, mountains.
 Don't belong: Plastic bottles, paint can, battery, cans, cardboard box, tires.

Illegal Dumping

Put an **X** on the things that *do not* belong in the desert.
 Color the things that *do* belong in the desert.

HELP
 ATTACK
 LITTERING &
 TRASHING



Wild Bill Pickup



Composting

Composting is a process where water and heat work with worms, insects and bacteria to break down organic material such as yard waste and leftover vegetables into a rich nutrient called humus (hyōō/mes). Humus has lots of good nutrients for soil and gardens. You can make humus in your own back yard by starting a compost pile. Many items of garbage can go into the pile, but some cannot.

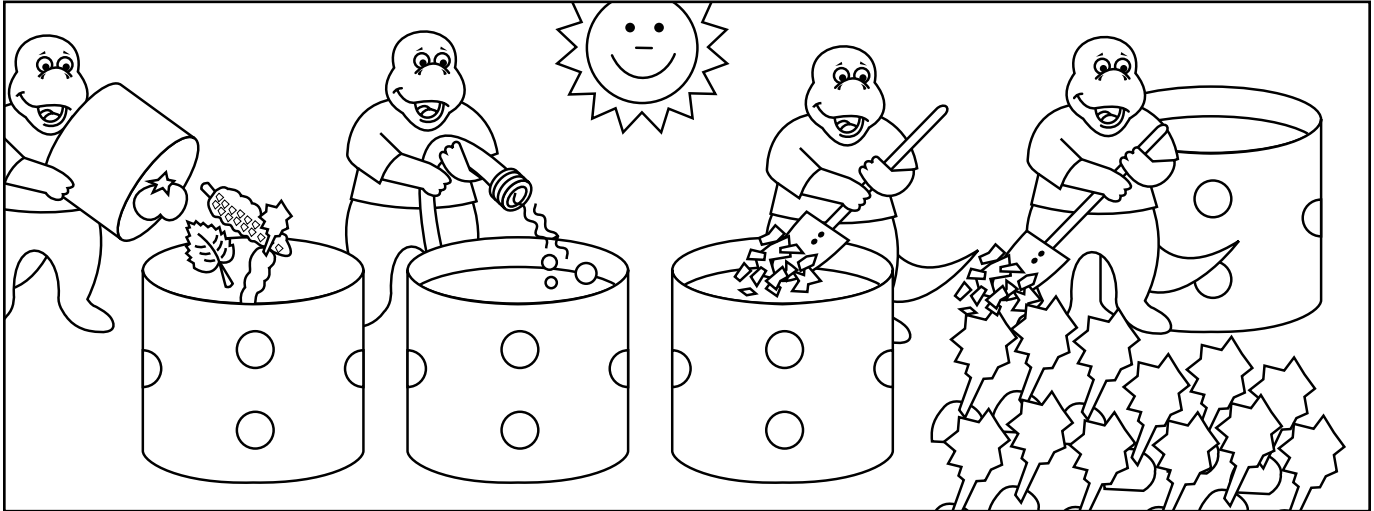

Combine yard, kitchen scraps to compost pile...

water...

turn...

wait several weeks then add to garden

Circle the items that can be composted

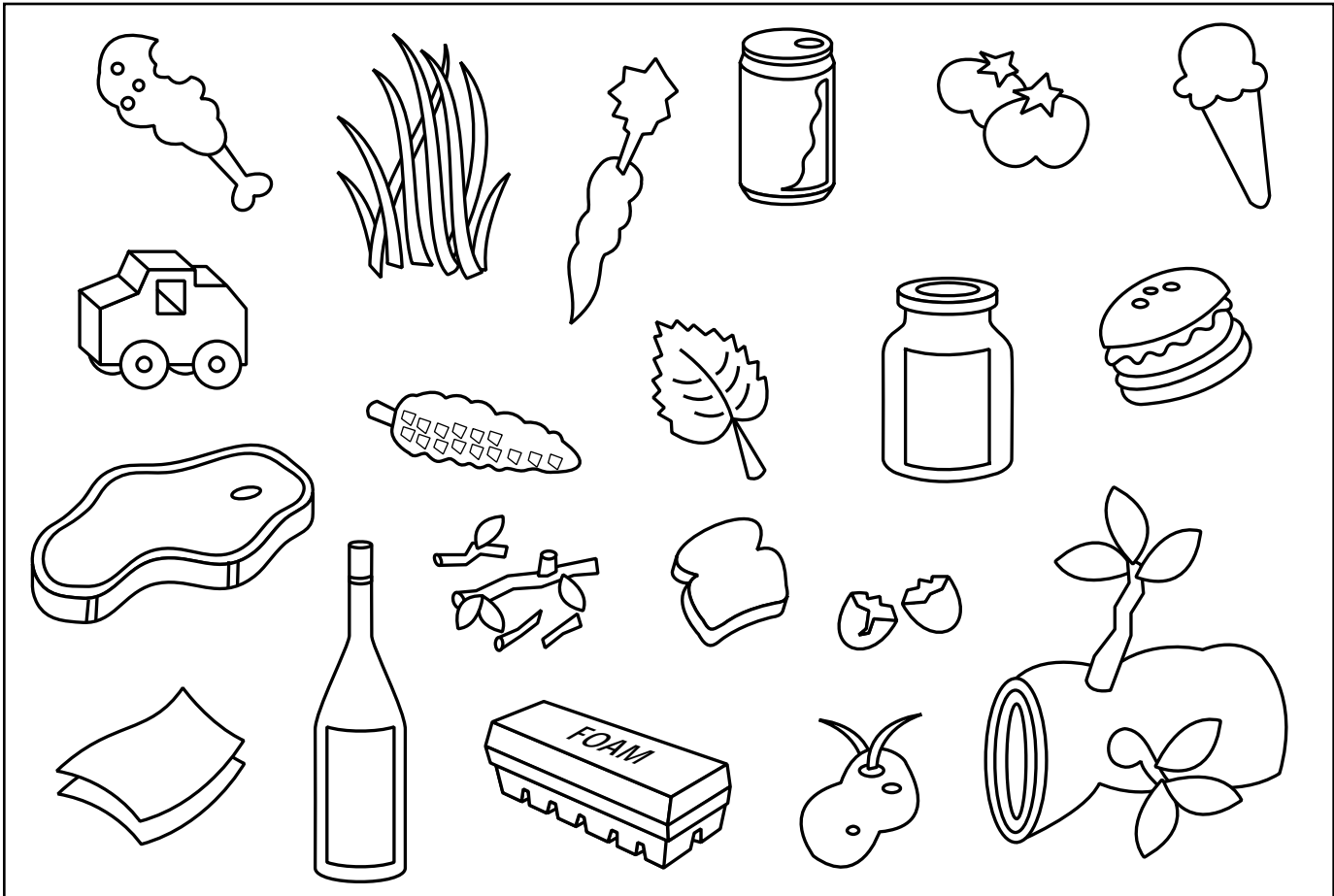

Can be composted: grass, carrot, tomato, log (if broken into pieces) and paper.

Household Hazardous Waste

BATTERY
OIL
PAINT
ANTI-FREEZE

Can you unscramble the words and identify some common household hazardous wastes?

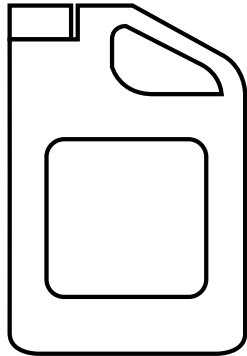

ezenaertfi



BUG
SPRAY



ANT
KILLER

ecisptdse

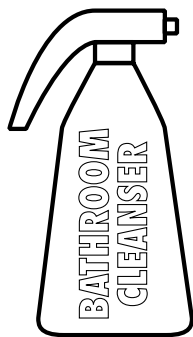

BATHROOM
CLEANSER

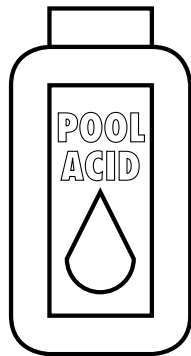

POOL
ACID



OVEN
CLEANER

shmeiclca

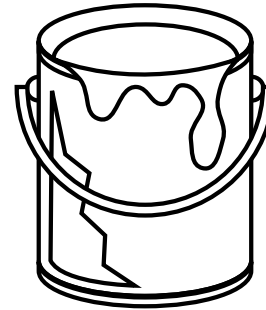

anpit

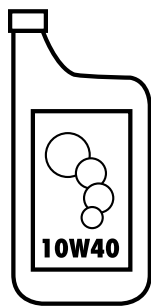

10W40

tomro iol

Remember to:

- Buy what you need.
- Use all you can.
- Share with your neighbor.
- Dispose of properly.

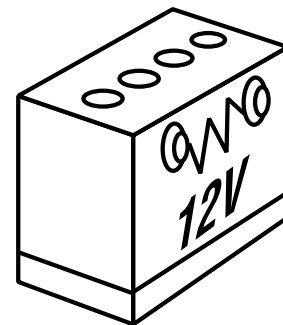

rac taybter

Answers: antifreeze, pesticide, chemicals, paint, motor oil, car battery

Household hazardous wastes are dangerous for people, animals and plants to eat and drink. If they are not disposed of properly they can get into our groundwater supply and contaminate it. If you find any of these around your house, ask an adult to take them to the next local hazardous waste collection event (B.O.P.A.'s are held monthly in Phoenix). For information call 602-262-7251 or e-mail: captoxic@ci.phoenix.az.us or visit our web site: www.ci.phoenix.az.us/GARBAGE/garbidx.html